

Technical Article

Air-cooled condensers in ammonia (NH₃) refrigerating plants as an alternative to evaporative condensers



Core topics:

Why are air-cooled condensers in ammonia plants an interesting alternative from today's point of view?

Different types of ammonia condensers

Comparison of advantages of air-cooled ammonia condensers and evaporative condensers

Ambient temperature limits for ammonia refrigerating plants with air-cooled condensers

Regions where air-cooled ammonia condensers can be used

Comparison of energy consumption and operating costs

Comparison of investment costs

Comparison of overall costs

Preface

In this presentation we will give you an overview in which regions and in which Ammonia refrigerating plants air-cooled condensers are an interesting alternative to evaporative condensers.

Contents

- 1. Why air-cooled condensers in Ammonia plants are an interesting alternative according to today's technology?**
- 2. Different types of Ammonia condensers**
- 3. Comparison of advantages**
- 4. Ambient temperature limits for Ammonia refrigerating plants with air-cooled condensers**
- 5. Regions of the earth adequate for using air-cooled Ammonia condensers**
- 6. Comparison of energy and water consumption**
- 7. Comparison of investment costs**
- 8. Comparison of operating costs**
- 9. Summary**

1. Why air-cooled condensers in Ammonia plants are an interesting alternative according to today's technology?

In the past 20 years plant engineering of Ammonia plants has changed and the price for electricity, water and wastewater have increased.

In some regions, water is scarce or there are restrictions on water use.

What has changed?

Compressors

In opposition to the past, screw compressors are predominantly used in Ammonia plants today.

Via the oil circulation system in the screw compressor, heat is dissipated and hot gas temperatures are produced that are much lower than the hot gas temperatures produced via reciprocating compressors.

Thus, screw compressors in Ammonia plants can be used for condensing temperatures up to 50-55°C.

Control

Modern control technology optimizes the operation of a plant.

By decreasing the condensing temperature to 20-25°C a lot of energy can be saved with Ammonia refrigeration plants. In this operation mode, high condensing temperatures are only relevant for a few hours per year. Thus, new perspectives arise for the cost-effectiveness of air-cooled condensers.

In evaporative condensers the condensing temperature decreases proportionally to the wet bulb temperature, in air-cooled condensers the condensing temperature decreases proportionally to the ambient temperature. This means that in air cooled condensers the condensing temperature decreases more intensely compared to evaporative condensers.

At ambient temperatures below appr. 20°C, refrigerating plants with air-cooled condensers reach lower condensing temperatures than plants with evaporative condensers.

Operating costs

The costs for energy, water and wastewater are increasing and will continue to increase.

According to the plant's location, the operating costs for evaporative condensers are often higher than the operative costs for air-cooled condensers.

Thus especially in regions with high costs for water and wastewater

Environmental awareness

Chemicals for water treatment pollute the environment and can not be discharged into wastewater treatment systems with unclarified water. In many regions of the earth drinking water is precious and scarce.

2. Different types of Ammonia condensers

There are three different types of Ammonia condensers.

2.1 Evaporative condenser

Most industrial Ammonia refrigerating plants are equipped with evaporative condensers.

Mode of operation of evaporative condensers:

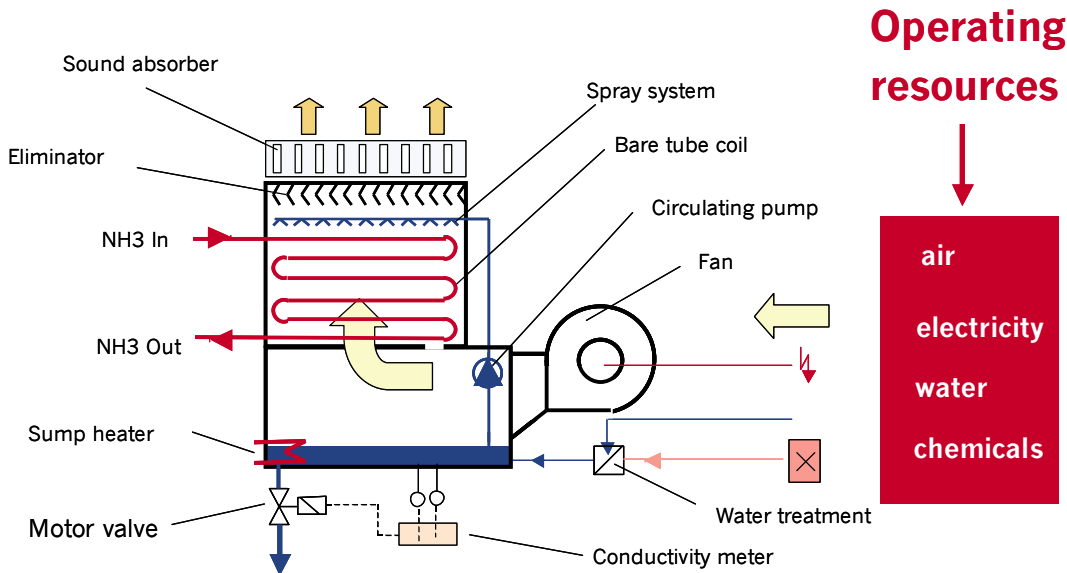
The refrigerant vapor flows through the closed tube system of a heat exchanger, the surface of the heat exchanger is constantly sprinkled with circumferential water.

Air is conducted with aspirating or forced draught fans through the heat exchanger; thereby the tube system is cooled and the circulating water evaporates partly.

Through the evaporation of the water, heat dissipates from the refrigerant vapor; this leads to the condensation of the refrigerant.

Due to the evaporating effect a condensing temperature that is approximately 10K lower than the condensing temperature of an air-cooled condenser is reached at high ambient temperatures.

Figure 1 Evaporative condenser



The evaporative condenser consists of the following parts:

- Casing
- Pipe coil for NH₃
- Fan
- Eliminator
- Spray nozzles for wetting water
- Tube system for spray nozzles
- Circulating pump for water spray
- Tray for circulating water
- Sound absorber (optional)
- In case of danger of frost: integrated heating or separate water tank with secondary pump

For the supply of cooling water the following equipment is necessary:

Wastewater treatment system for fresh water

(Adding of chemicals: biocides, corrosion protection, hardness stabilizers) conductimetry

Motor operated valve for desalination

The supply with cooling water leads to additional operating costs through fresh water, wastewater, chemicals, the installed equipment and the monitoring of the refrigerating plant with qualified personnel.

Required operating media for evaporative condensers:

- Air
- Electricity
- Fresh water
- Chemicals
- (Wastewater)

2.2 Hybrid condenser

A hybrid condenser is the combination of an evaporative condenser and an air-cooled condenser. There are different types of hybrid condensers the construction and operation of which will not be discussed here

Mode of operation of a hybrid condenser:

The refrigerant vapor flows through a finned heat exchanger or through a combination of finned and non-finned heat exchanger. Due to the large surface of the integrated finned heat exchanger it is possible to operate this system up to a defined ambient temperature (e.g. 15°C) without using a water spray system.

Only at higher ambient temperatures the heat exchangers are wetted to make use of the evaporating effect and to reach a low condensing temperature.

Through the systematic use of the water application and the control of the fan speed, the fin surface is only partly wetted. Thus it is possible that only the amount of water evaporates that is necessary to obtain the pre-determined condensing temperature.

This classic hybrid cooler has three operating states:

Operating state 1, at low ambient temperatures:

Cooling of the heat exchangers with dry air.

The system operates like an air-cooled condenser.

Operating state 2, at medium ambient temperatures:

The heat exchanger surface is wetted partly with water.

The system operates partly as an air-cooled condenser and partly as an evaporative condenser.

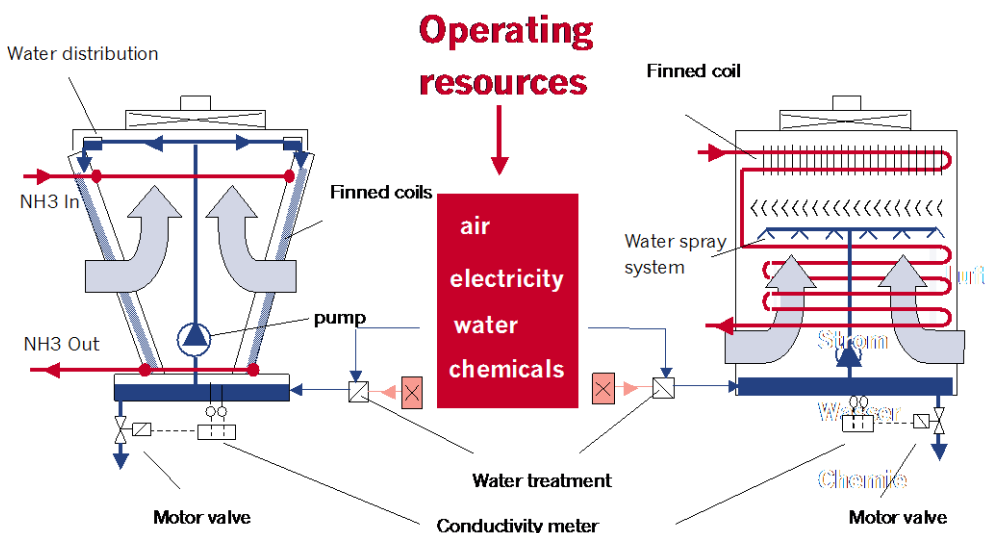
Operating state 3, at high ambient temperatures:

The heat exchangers are wetted completely.

The system operates as an evaporative condenser.

Hybrid condensers only consume a part of the cooling water that is used for the evaporative condenser. Despite high investment costs the hybrid condensers become more and more cost-efficient due to increasing water and wastewater costs. In operating state 3, the same low condensing temperatures are reached as with the evaporative condenser.

Figure 2 Hybrid condenser



The hybrid condenser consists of the following parts:

- Heat exchanger or additional heat exchanger as tube system with fins
- Fan
- Water dissipation with overflow gutters or water spray system
- Piping for water dissipation
- Circulating pump for wetting water
- Tray for wetting water

For the water treatment in a hybrid condenser, the same equipment are required as for the evaporative condenser. Heating to prevent the freezing of the water or an additional water tank are not necessary. For the standard design of hybrid condensers at an ambient temperature below +5°C to +10°C wetting water is not needed anymore and is discharged by means of a valve.

Required operating media for hybrid condensers:

- Air
- Electricity
- Fresh water
- Chemicals
- (Wastewater)

2.3 Air-cooled condensers

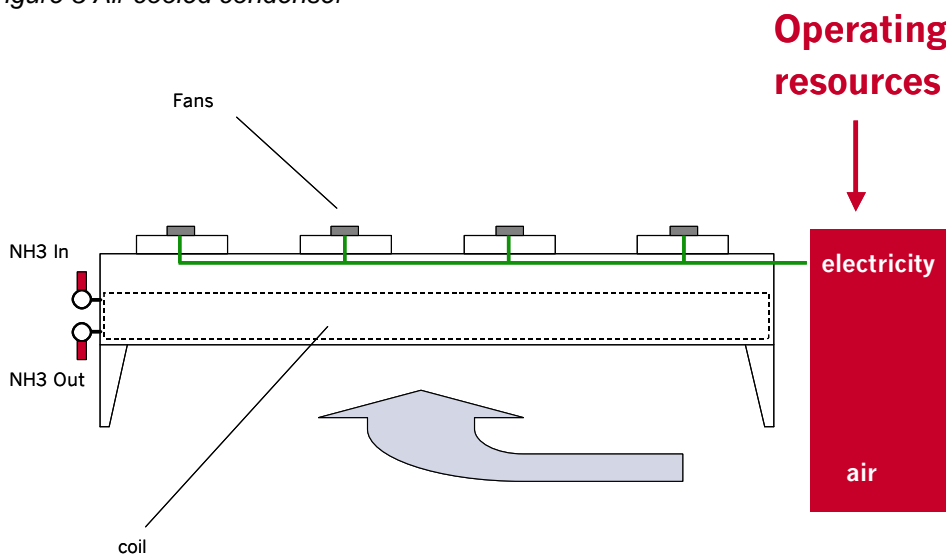
Most Freon refrigerating plants are equipped with air-cooled condensers

During the past years, air-cooled condensers are used increasingly for Ammonia refrigeration plants, especially in regions with high costs for water and wastewater,

Mode of operation of air-cooled condensers:

In air-cooled condensers refrigerant vapor flows through the tube system of a finned heat exchanger. The fans aspirate the air through the heat exchanger so that the refrigerant vapor is cooled down and condensed. The condensing heat is only dissipated by the means of the cooling of the heat exchanger with air. At an economical design the condensing temperature is approx. 10-12K higher than the ambient temperature

Figure 3 Air cooled condenser



The air-cooled condenser consists of the following parts:

- Casing with feet for floor mounting
- Heat exchanger as tube system with fins
- Axial fans

Required operating media:

- Air
- Electricity

The air-cooled condenser is the simplest system of all construction types and comprises only few parts. There are no additional operating costs except costs for electricity power.:

4. Other variants

Besides the three presented construction types of NH₃ condensers, other variants exist, e.g.:

- Evaporative condensers with integrated finned heat exchanger as desuperheater or adiabatic precooler.

Summary:

The costs for energy, water and wastewater have increased, therefore many manufacturers developed new unit combinations in the last years with the aim to economize expenses for electricity, water and wastewater. All systems with evaporative cooling however require water supply with the therefore necessary components and the corresponding chemicals. A system that works completely without cooling water and without chemicals is therefore the best solution.

3. Comparison of Advantages

Figure 4: Advantages air-cooled condensers / evaporative condensers

Advantages

Air-cooled condensers	Evaporative condensers
<ul style="list-style-type: none"> - No water consumption - No problems with frost -No plant for water treatment - No costs for chemicals - No costs for wastewater - No fog formation - No danger of legionella bacteria - Low weight - Maintenance-free - Simple system. 	<ul style="list-style-type: none"> - Condensing temperature is lower but only if the ambient temperatures over app. 20° C - Lower energy consumption - Saving of investment costs - Smaller plan area - Smaller driving power for compressors.

4. Temperature-use limit for NH₃ plants with air-cooled condensers

At an efficient design, the condensing temperature of air-cooled NH₃ condensers is approximately 10-12K above the ambient temperature. When designing NH₃ refrigerating plants with air-cooled condensers the following criteria have to be considered:

- Temperature-use limit of compressors
- Max.ambient temperature at the installation site
- The load profile of the refrigerating plant

4.1 Temperature-use limits due to the compressor types

Depending on the refrigerant compressor, different condensing temperatures are permissible.

Average maximum condensing temperatures

- For reciprocating compressors 40°C
- For reciprocating compressors with cylinder head cooling 45°C
- For screw compressors 50-55°C

4.1 Temperature-use limits depending on the maximum ambient temperature on the installation site

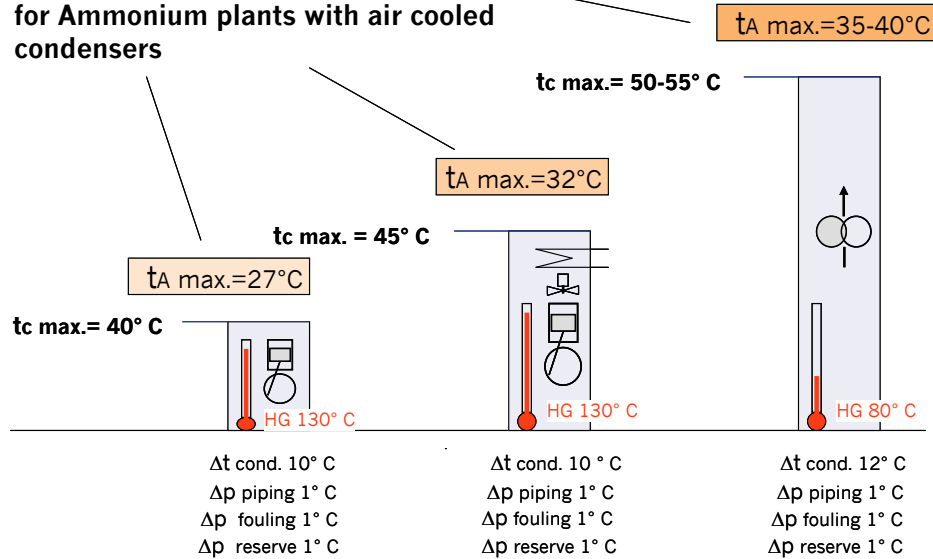
If you assume that in general reciprocating compressors are used for plants with low or medium performance, it makes sense to use air-cooled condensers for this kind of plants with a dt of 10K between ambient temperature and condensing temperature.

Usually screw compressors are used for plants with a high performance. In order to limit the number of condensers and to keep the setting-up area as small as possible, we have taken a dt of 12K as a basis for screw compressors. If you consider 1K additionally for the pressure drop in the oil separator and in the piping and 1K for the fouling of the condenser, the following temperature-use limits for the maximum ambient temperatures result for the different compressor types:

Reciprocating compressor 27°C
 Reciprocating compressor with cylinder head cooling 32°C
 Screw compressor 35-40°C

Figure 5 Ambient temperature limits depending on the compressor types

Maximum ambient temperatures for Ammonium plants with air cooled condensers



4.2 Maximum ambient temperatures regarding the load profile of the refrigerating plant

For the design of a refrigeration plant, you have to distinguish if it is a plant that has to provide 100 % refrigerating capacity all the time or if capacity adjustments are possible over a 24-hour period.

Refrigeration plants for the cooling of process engineering plants or manufacturing plants, for example, have to provide 100 % cooling capacity all the time. Therefore, air-cooled condensers can only be used in regions which comply with the above mentioned temperature conditions.

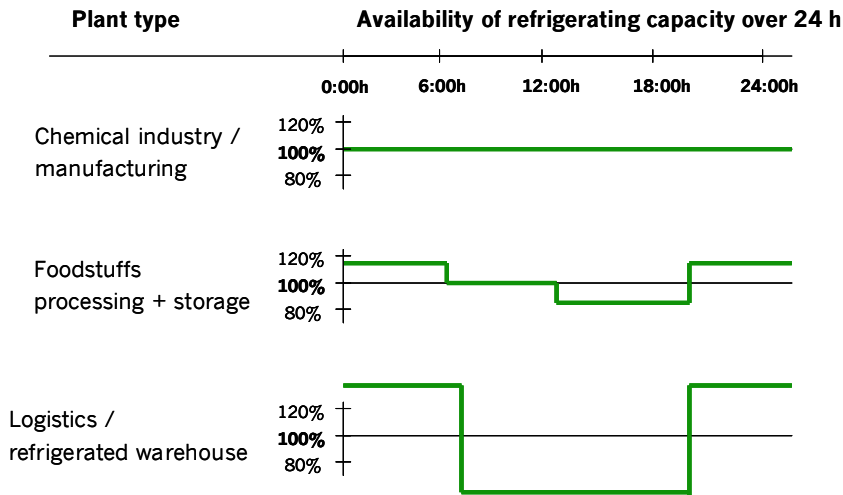
Refrigeration plants in the field of logistics can be operated at different load levels over a 24-h period if required. In refrigerated warehouses, for example, it is possible to reduce the cooling capacity at high ambient temperatures during the day in order to maintain the maximum condensing temperature.

During day time, high ambient temperatures occur only for a few hours, the plants can then be operated during night time with a higher cooling capacity to compensate the deficit.

In this kind of operation it is possible to use air-cooled condensers in those regions where the peak values of ambient temperatures is higher than 35-40°C.

In addition, for this kind of operation, smaller drive motors can be dimensioned for the compressors and energy costs can be saved due to the operation of the plant at low ambient temperatures during night time.

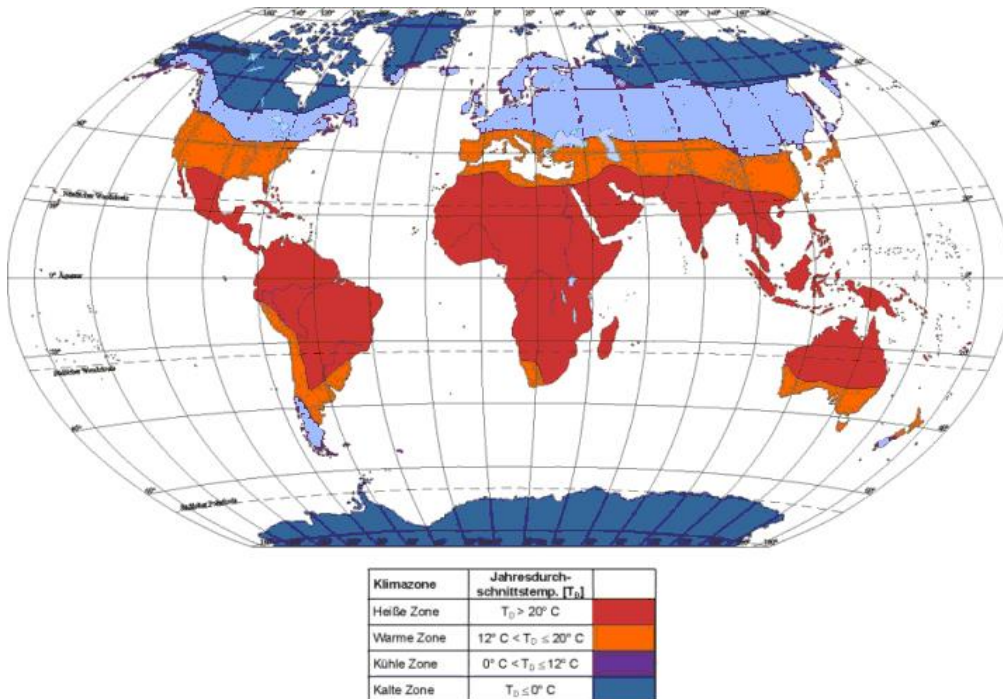
Figure 6: Load profile of different refrigerating plants



5. Regions of the earth adequate for using air-cooled Ammonia condensers

For NH₃ refrigerating plants with screw compressors, air-cooled condensers can be used without restriction in regions with a maximum ambient temperature of 35-40°C. If the ambient temperatures exceed the value of 35-40°C for a short time, it is necessary to reduce the performance for a short time or to spray water on the condenser.

Figure 7: Regions of the earth adequate for using air-cooled Ammonia condensers



This figure shows an overview of the regions where ammonia condensers can be used. They are especially suitable for industrial countries in Europe, America and part of Asia.

Blue zone: unlimited use possible

Yellow zone: reduction of the performance at high ambient temperatures, or water spray with tap water for max. 200 h/year.

The climate and the ambient temperatures depend however on the location of the installation site and are influenced among others by the proximity to the ocean and the height above sea level.

6. Comparison of operating costs

An application often occurring in practice is examined to compare the operating costs.

Evaporating temperature: -10°C

Condensing temperature: 47°C air-cooled condenser

Condensing temperature: 35°C evaporative condenser

Ambient temperature 35°C

These parameters apply to one-stage as well as to two-stage NH₃ refrigerating plants, because normally the high pressure stage of a two-stage refrigerating plant is operated with an evaporating temperature of -10°C and the condensing temperature only has a bearing on the high pressure stage.

The assumed maximum ambient temperature is set at 35°C. Considering the pressure drops in the piping and a fouling factor for the condenser, the maximum condensing temperatures of 37°C and 49°C respectively result.

For the oil cooling a separate drycooler is used. The high temperature level of 45-70°C for the cooling fluid is recommended to be used for heat recovery, thus compensating a part of the energy costs for the compressors.

Figure 8: Example of an Ammonia refrigerating plant for the comparison of the cost-effectiveness

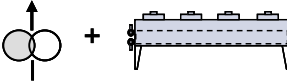

Plant description		
Compressors	3xscrew comp. Grasso V-2	3xscrew comp. Grasso V-2
Total Refrig. capacity	3150 KW (-6.8 %)	3380 KW (-0 %)
Evaporating temp.	-10 °C	-10 °C
Condensing temp. at compressor	49 °C	37 °C
Condensing temp. at condenser	47 °C	35 °C
Max. drive power of all compressors	1205 KW	980 KW
Condensers	5xGüntner AGVH 100.2A2x5N	2xBAC CXV-280
condensing capacity	3560 KW	3840 KW
Ambient temperature	35 °C	Wet-bulb 22.5°C
Fans	Axial- 50 x 2,2 KW	Axial- 4 X 11 KW
Speed control of Fans	Frequency converter	Frequency converter
Pumps		2 x 4 KW (integral pumps)
Fluid cooler for oil cooling	820 KW	500 KW

Figure 9: Diagram of the Ammonia refrigeration plant with air-cooled condensers for this example

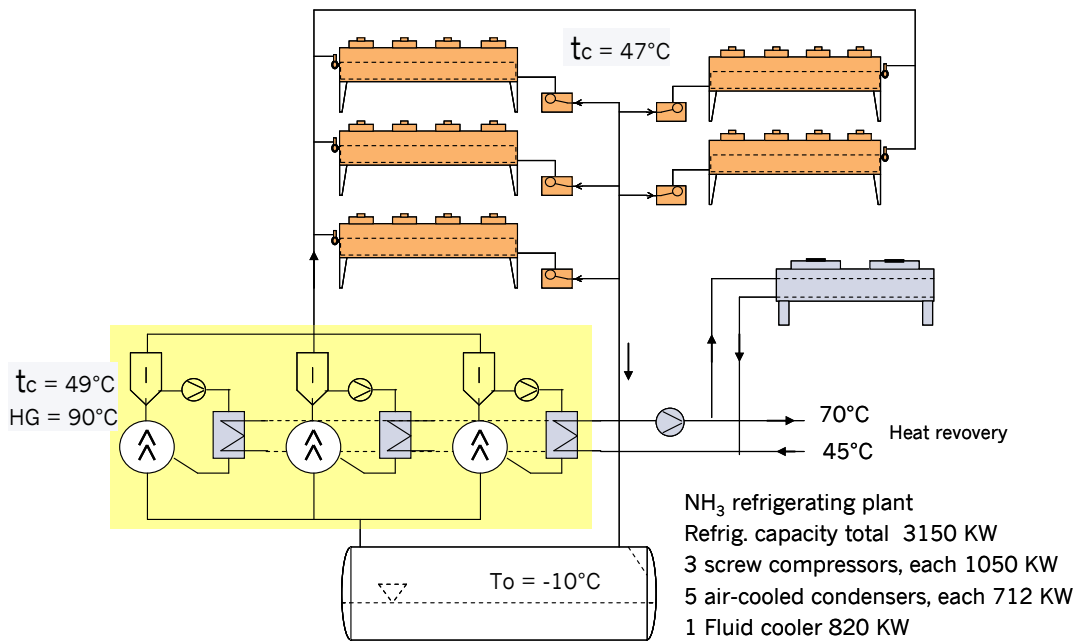
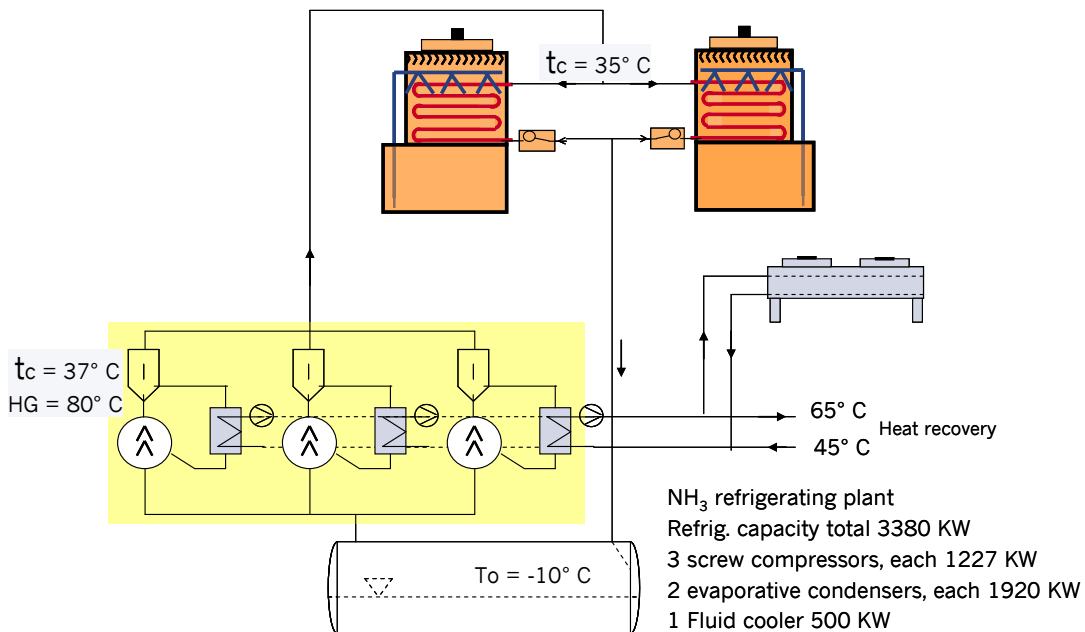


Figure 10: Diagram of the Ammonia refrigeration plant with evaporative condensers for this example



For the comparison of the two systems, we examine first the energy consumption of the compressors and second the consumption of energy and water for the different condenser systems.

6.1 Comparison of the energy consumption for the compressors

The highest energy consumption in a refrigerating plant is caused by the compressors. The energy consumption of the compressors is primarily determined by the level of the condensing temperature.

In order to calculate the energy and water consumption for both systems for one year, it is necessary to take into account the complete profile of ambient temperature, wet-bulb temperature and condensing temperature over a one-year period.

At high ambient temperatures the evaporative condensers reach lower condensing temperatures than air-cooled condensers.

The condensing temperature of evaporative condensers decreases proportionally to the wet bulb temperature. The condensing temperature of an air-cooled condenser decreases proportionally to the ambient temperature. Therefore, at falling ambient temperatures, the condensing temperature of an air-cooled condenser decreases faster than the condensing temperature of an evaporative condenser. This leads to the fact that, at an ambient temperature below 18-21°C lower condensing temperatures can be reached with an air-cooled condenser than with an evaporative condenser.

Figure 11 shows the progression of the condensing temperature of both systems against ambient temperature.

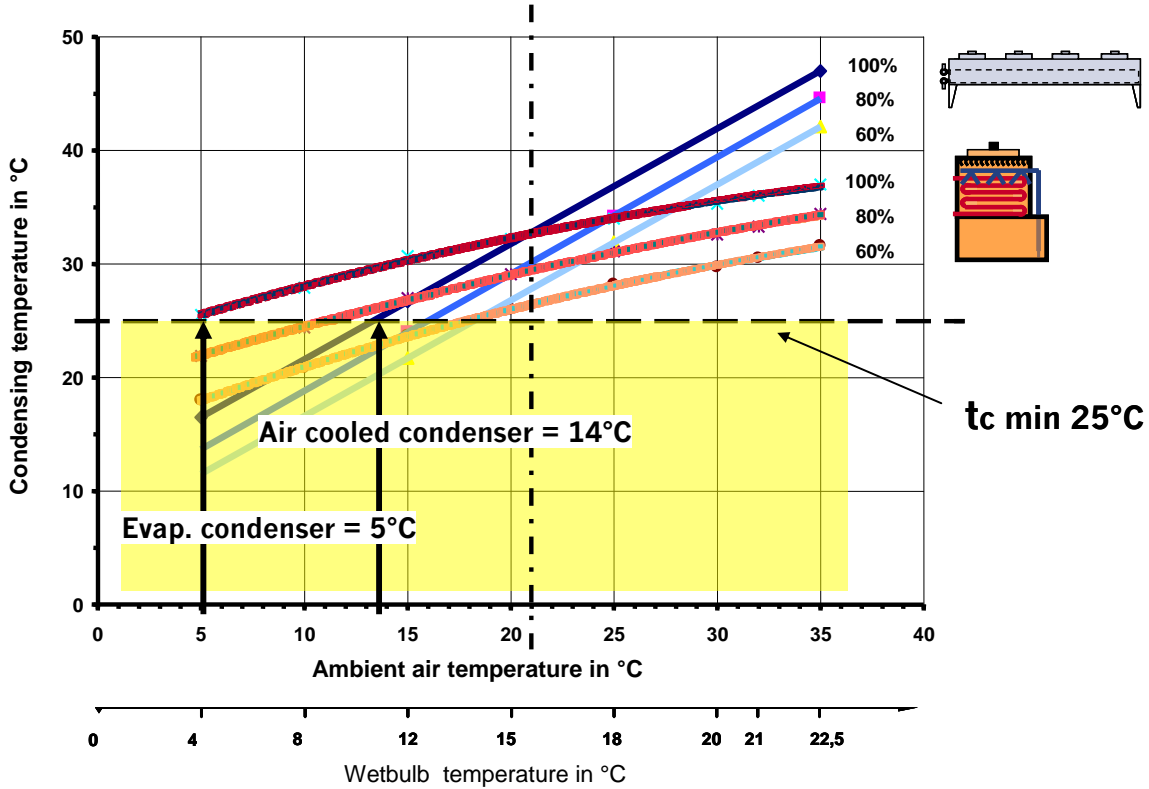


Figure 12: Comparison of the energy consumption for compressors

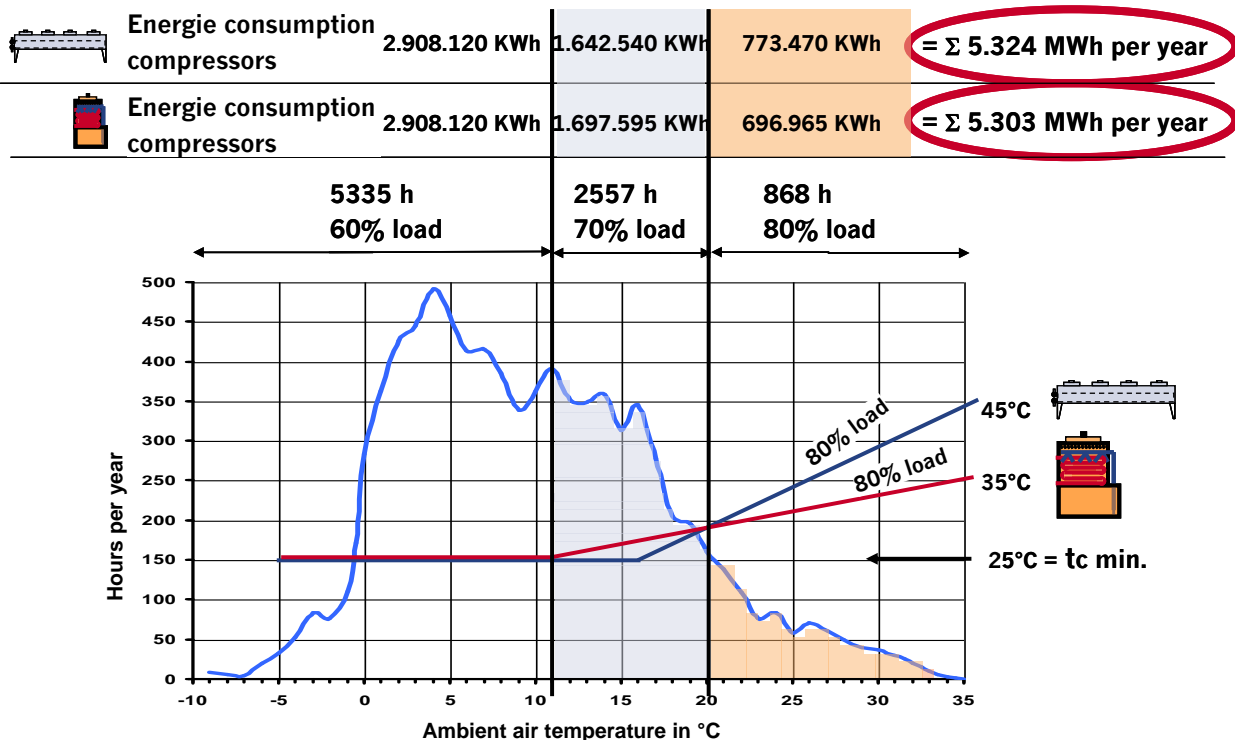


Figure 12 shows the progression of the temperature frequency in hours per year for a installation site in Germany (Essen)

For the evaluation of the energy costs, the progression of the condensing temperature is shown at a performance of 80 % of the refrigerating plant.

The minimum condensing temperature is assumed at 25°C.

During 868 h/year the driving power of the compressors is higher in combination with air-cooled condensers than with evaporative condensers.

During 2557 h/year the driving power of the compressors, is lower in combination with air-cooled condensers than with evaporative condensers.

During 5335 h/year the driving power of the compressors is the same for both systems, because the minimum condensing temperature of 25°C is reached.

Conclusion: If you multiply the drive power of the compressors with the proportionate operating hours per year, you arrive at the conclusion that both systems have the same energy consumption of the compressors per year in this example.

6.2 Comparison of operating costs for condensers

The annual operating costs for an evaporative condenser have been calculated as shown below:
A medium capacity utilization of the Ammonia refrigerating plant is assumed with:

- 80 % at ambient temperature of 20-35°C
- 70% at ambient temperatures of 11-19°C
- 60% at ambient temperatures below 11°C

When the minimum condensing temperature of 25°C is reached, the fan speed of all fans is reduced for both systems with a frequency converter.

Figure 13: Comparison of energy and water consumption for both condenser systems

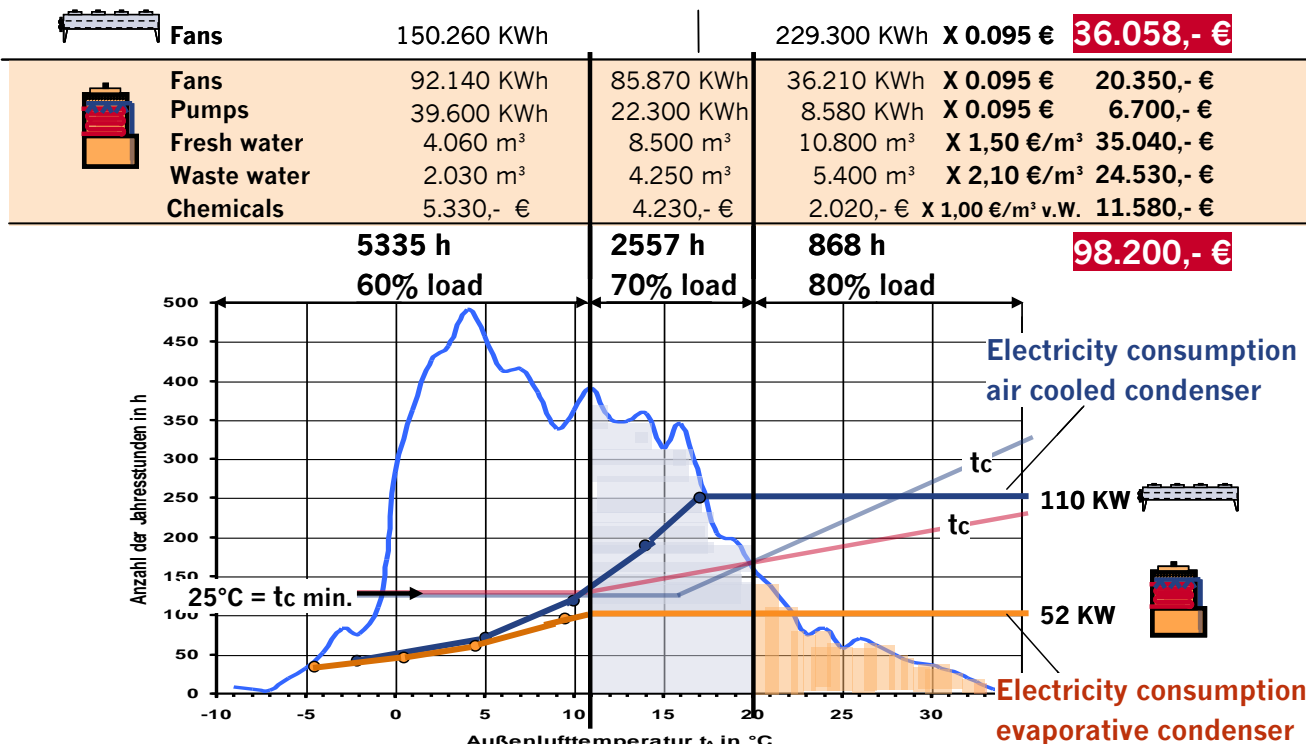


Figure 13 shows the energy and water consumption for both systems depending on the ambient temperature over one year.

In the upper area of the figure, the energy consumption of the air-cooled condensers is shown.

Below, the energy and water consumption for the evaporative condensers is shown.

At 17°C ambient temperature the air-cooled condensers have reached the minimum condensing temperature of 25°C and the fan speed is reduced.

At 11°C, the evaporative condensers have reached the minimum condensing temperature and the fan speed is also reduced with frequency converters.

At -10°C, the pumps switch off and the fans of the evap. condensers operate at full speed.

Assumed costs for this calculation.

Electricity costs: 0,095 € /kWh

Costs for fresh water: 1,50 € /m³

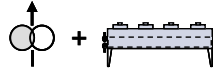



Costs for wastewater: 2,10 € /m³

Costs for chemicals: 1.00 € /m³ evaporated water

Through the use of frequency converters, the energy consumption of the fans is optimized. This is a great advantage especially when using air-cooled condensers.

Comparison of operating costs for the complete installation

Figure 14 Comparison of operating costs for the complete installation per year

Operating costs per year	 +  Plant with air cooled cond.	 +  Plant with evap. cond.
Electricity compressors 9,5 ct./KWh	505.780,- €	503.785,- €
Electricity fans 9,5 ct./KWh	36.058,- €	20.350,- €
Electricity pumps 9,5 ct./KWh	---	6.700,- €
Fresh water (1,50 €/m ³)	---	35.060,- €
Waste water (2,10 €/m ³) (Eindickung: 3-fach)	---	24.530,- €
Chemicals (1,55 €/m ³)	---	11.580,- €
Maintenance	2.000,- €	4.000,- €
Electricity for oilcooler 9,5 ct./KWh	8.000,- €	6.000,- €
Total operating costs per year	46.000,- € - 60.000,-€	106.000,- €

The comparison of the operating costs leads to the following result:

All year long, the energy consumption of the compressors is the same for both systems

The operating costs for the evaporative condensers depend very much on the costs for water and wastewater.

In countries, where the prices for fresh water and wastewater are on a high level the operating costs for air-cooled condensers are lower than for evaporative condensers.

Comparison of investment costs

For the calculation of the investment costs we assumed the following:

Construction of the plant as shown in figures 8, 9, 10

Piping and connections of condensers with high pressure float valve

Regulation of the fan speed of the condensers with frequency converter

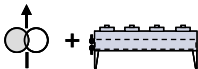

Installation of the condensers on the roof of a building

Figure 15: Comparison of the investment costs

Investment costs	Air-cooled condenser 5x Güntner AGVH 100.2A 2x5N	Evaporative condenser 2x BAC CXV-280
Additional charge compressors	2.700,- (prop. 7%)	---
Additional charge oil cooler	2.400,-	---
Additional charge drive motor	7.500,-	---
Price per unit, installation incl.	145.000,-	76.600,-
Steel construction, substructure	10.800,-	5.500,-
Water treatment plant	---	21.900,-
Piping, high pressure floater incl.	20.300,-	17.200,-
Drycooler for oil cooling	20.200,-	12.700,-
Piping and pump for drycooler	9.850,-	8.850,-
Electric panel with frequency controller	19.800,-	16.600,-
Electric wiring	7.700,-	6.000,-
Water tank + pump		16.000,-
Overall costs	246.250,- € + 65.000,-€	181.350,- €

Comparison of total costs

Figure 16: comparison of total costs

Comparison of overall costs		
Investment costs	246.250,- €	181.350,- €
Operating costs per year	46.000,- €	106.000,- €
Total costs in 15 years (without interest and without price increase for energy and water)	936.250,- €	1.771.350,- € Savings 835.100,-

Summary

Advantages of air-cooled condensers

- No additional energy costs for the compressors
- No water treatment, therefore less operating costs and less maintenance requirements
- No environmental pollution
- No problems due to freezing water
- No use of valuable drinking water

For many NH₃ refrigerating plants in Europe, America, and partly in Asia air-cooled condensers are an interesting alternative to evaporative condensers.

With prices for water and wastewater increasing, air-cooled condensers offer economical advantages due to lower operating costs.

Contrary to the widely spread opinion, no additional energy costs for the compressors are incurred at an adequate operating mode.

The simple system and the low maintenance costs are another advantage.

The resource energy as well as the resource water is limited.

Which kind of condenser to use in an Ammonia plant has to be considered for each application individually.